

**HYMER**



Canadus 2016 Presentation

# The Electrical System

---

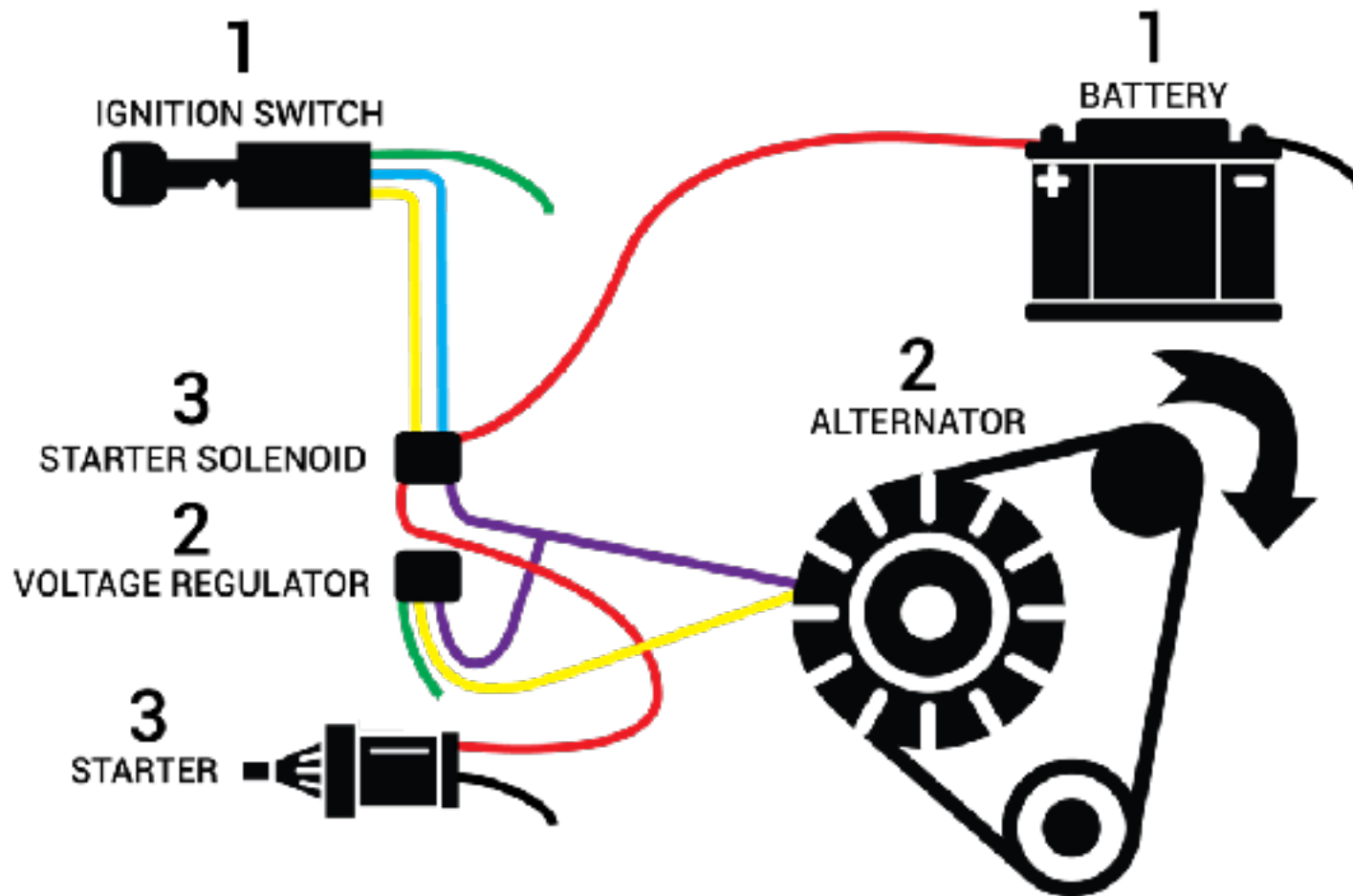

# Do you have a battery problem...

- Charging is inefficient
- Batteries lose capacity over time
- All batteries eventually fail
  - 20% from mechanical failure
  - **80% from chemical failure**



# The Problem: Sulfation

---

- Occurs in every lead acid battery
- Is accelerated by:
  - Repeated cycling (and inadequate charging)
  - Excessive battery discharge
  - Lack of battery use (promotes self discharge)
  - Leaving batteries in a discharged state for extended periods of time



# Available Energy

---

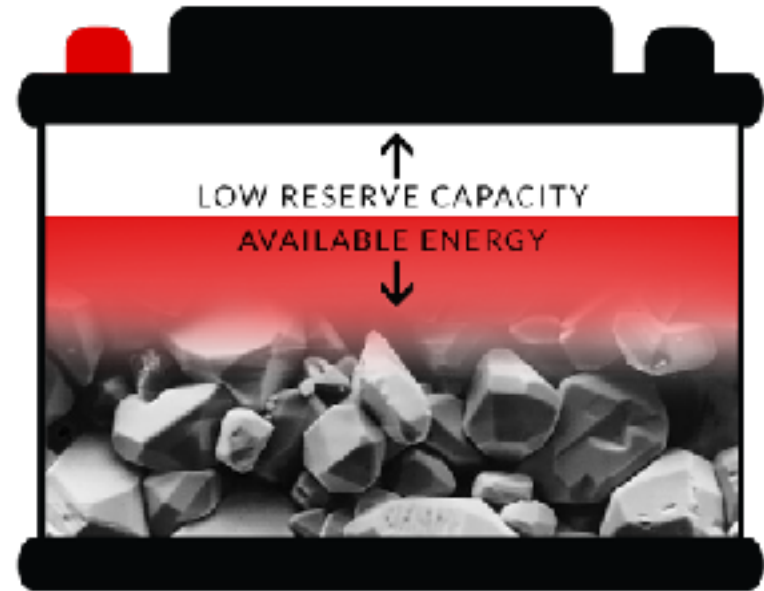
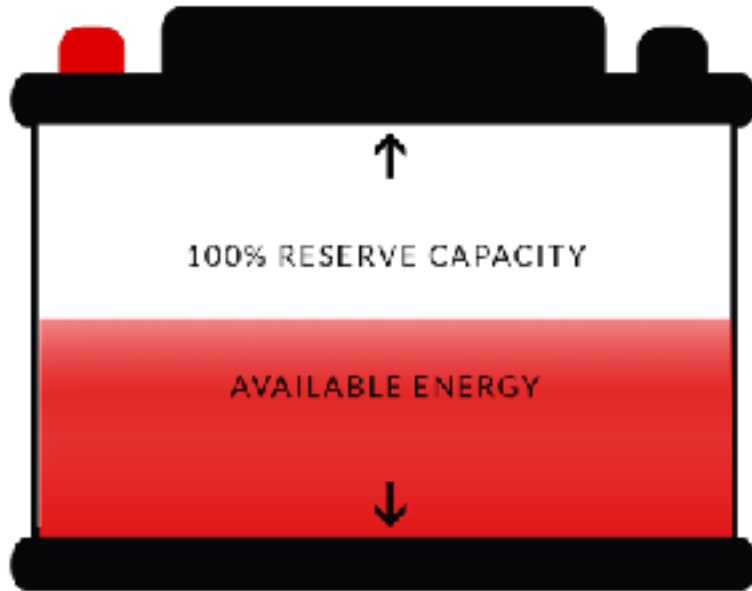

Crystalline Lead Sulfate decreases reserve capacity!



# Sulfation: It is a Chemical Reaction

---

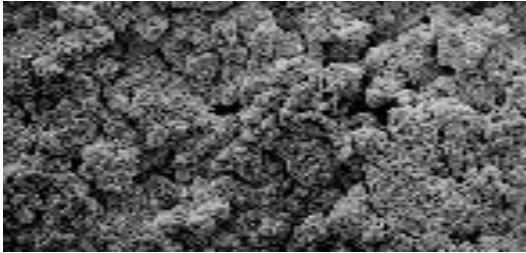

New Battery Plate  
("Sponge Lead")



Sulfated Battery Plate (Lead  
Sulfate Crystals)

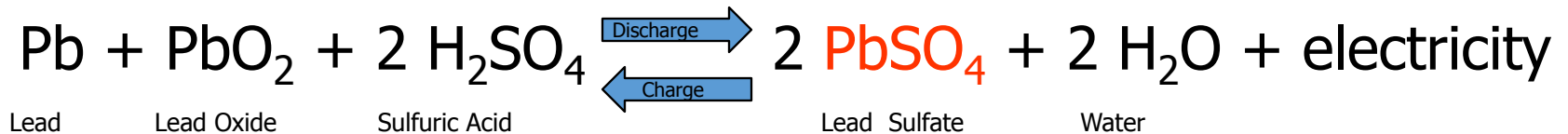

**Crystalline PbSO<sub>4</sub>**  
Cannot "recharge"



# Impact of Sulfation...

---

- Causes Chronic Low Voltage in batteries, resulting in premature failure of...
  - Batteries
  - Starter Motors and Alternators
  - Electronics
  - Lights
- Reduces the battery's capacity to absorb voltage spikes, decreasing light bulb life
- Causes the battery to be unreliable

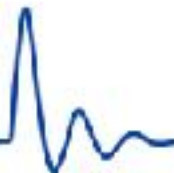

# The Solution: HD-1224 Battery Reconditioner

---

## •Advantages and Benefits

- For use with both 12V and 24V vehicle electrical systems
- Reverses and prevents the harmful effects of battery sulfation.
- Extends battery life at peak performance
- Extends alternator
- Cold cranking amps (CCA) and volts stay strong.
- Reduces no-starts
- A single unit can be used with up to eight 12-volt Group 31 batteries in parallel configuration.





# Battery Reconditioner Attacks Hardened Sulfate Crystals

---

- **80% of battery failure is due to chemical failure**, and the root cause of chemical failure is SULFATION.
- The Battery Reconditioner can prevent, and even reverse SULFATION.

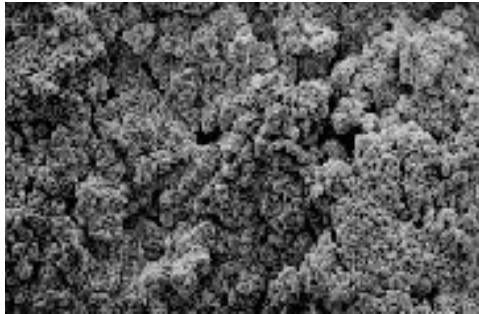

New Battery Plate



Sulfated Battery Plate



Battery Plate Partially  
Desulfated by Reconditioner

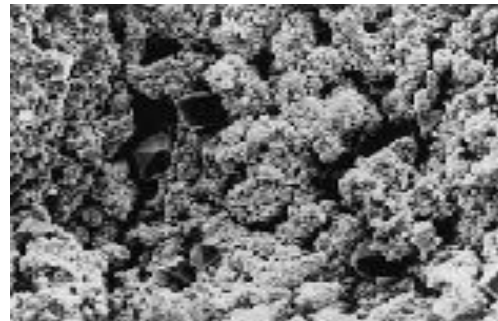

Battery Plate Desulfated by  
Reconditioner



# Canadus HD-1224: Not A Copy

- Summary of Canadus Patents for both SLI and MP battery applications;
  - US5648714 - Method and Device for Charging and Conditioning Batteries 7-15-97
  - US7535202 - Adjustable Input Pulsation Device 5-19-09
  - US7656128 - System and Method for Charging and Pulsating Batteries 2-2-10
  - US7675268 - Post Charge Battery Maintenance 3-9-10
  - US8058843 - Asymmetric Battery Pulsation System 11-15-11
  - US8164469 - System and Method for Controlling Battery Cool-Down 4-24-12
  - US8129954-CON - System and Method for Charging and Pulsating Batteries 3-6-12
  - US8169194 - System and Method for Applying Pulsation Energy to Online Backup Battery Systems 5-1-12
  - US8525485-CON - System and Method for Applying Pulsation Energy to Online Backup Battery Systems 9-3-13



# Canadus Quality Certifications

---

- Canadus:
  - ISO 9001
  - ISO 14001
- HD-1224:
  - “E-Mark” approval for UNECE Regulation 10.04
  - ADR Conformance
  - IP67, and IP6K9K
  - UL 94 V-0 compliance tested
  - ISO 16750 sections 1 through 5 compliance
  - Nato # 6130-01-643-3339
  - Volvo Standards
    - ISO 7637 sections 1-3
    - ISO 10605 (ESD, electrostatic discharge)
    - RF acceptable



# Canadus Desulfation Test: Parameters

- 6 Exide, Commercial Series 31D Batteries
- Age: approximately 2 years
  - Emergency Vehicle
  - In service, not due for replacement
- Rating: 660 CCA / 160 minutes of Reserve Capacity at 25 amps



# Desulfation Test

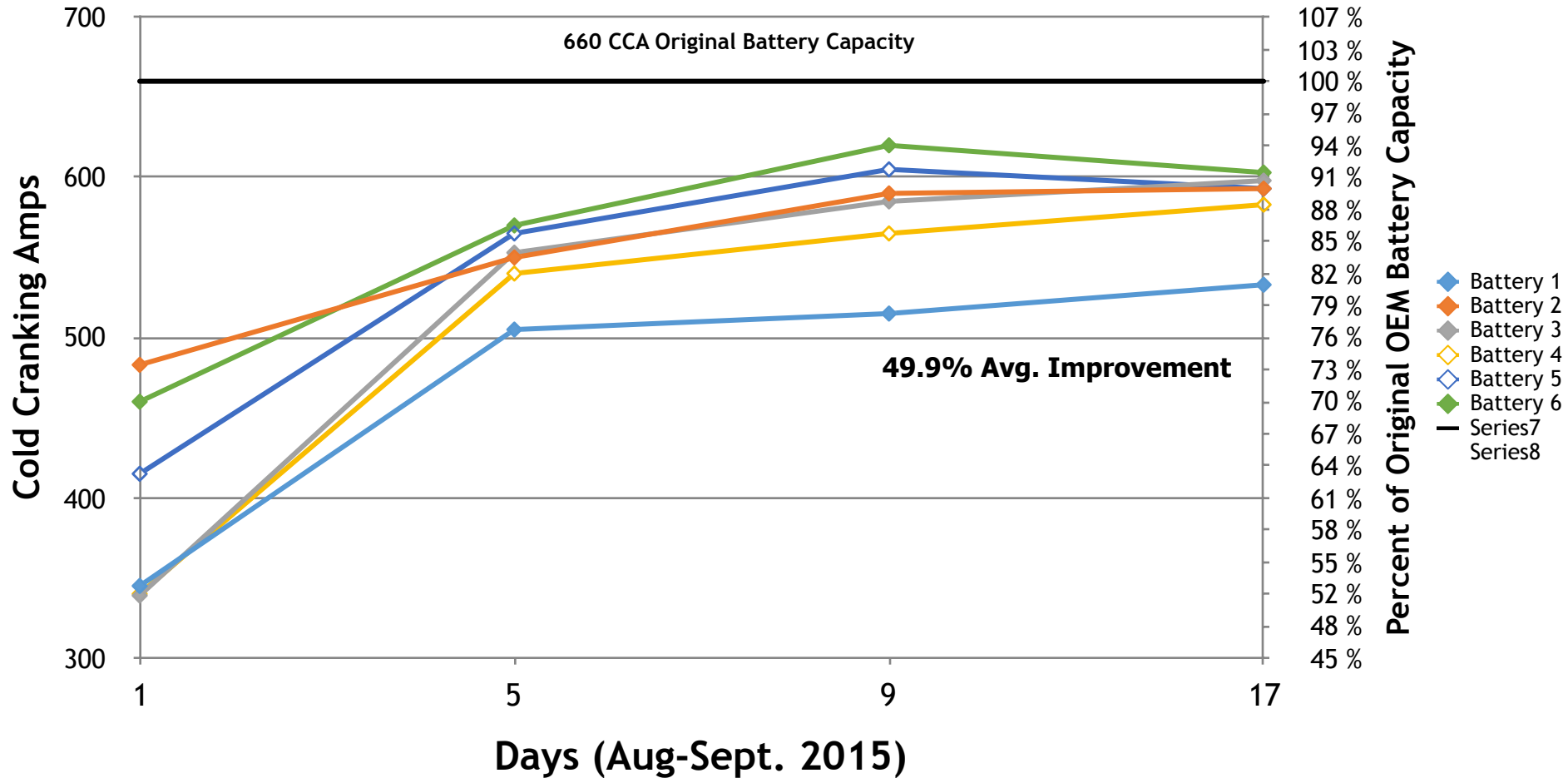

# Desulfation Test

## Load Test Results (Avg. Batteries 1-6)

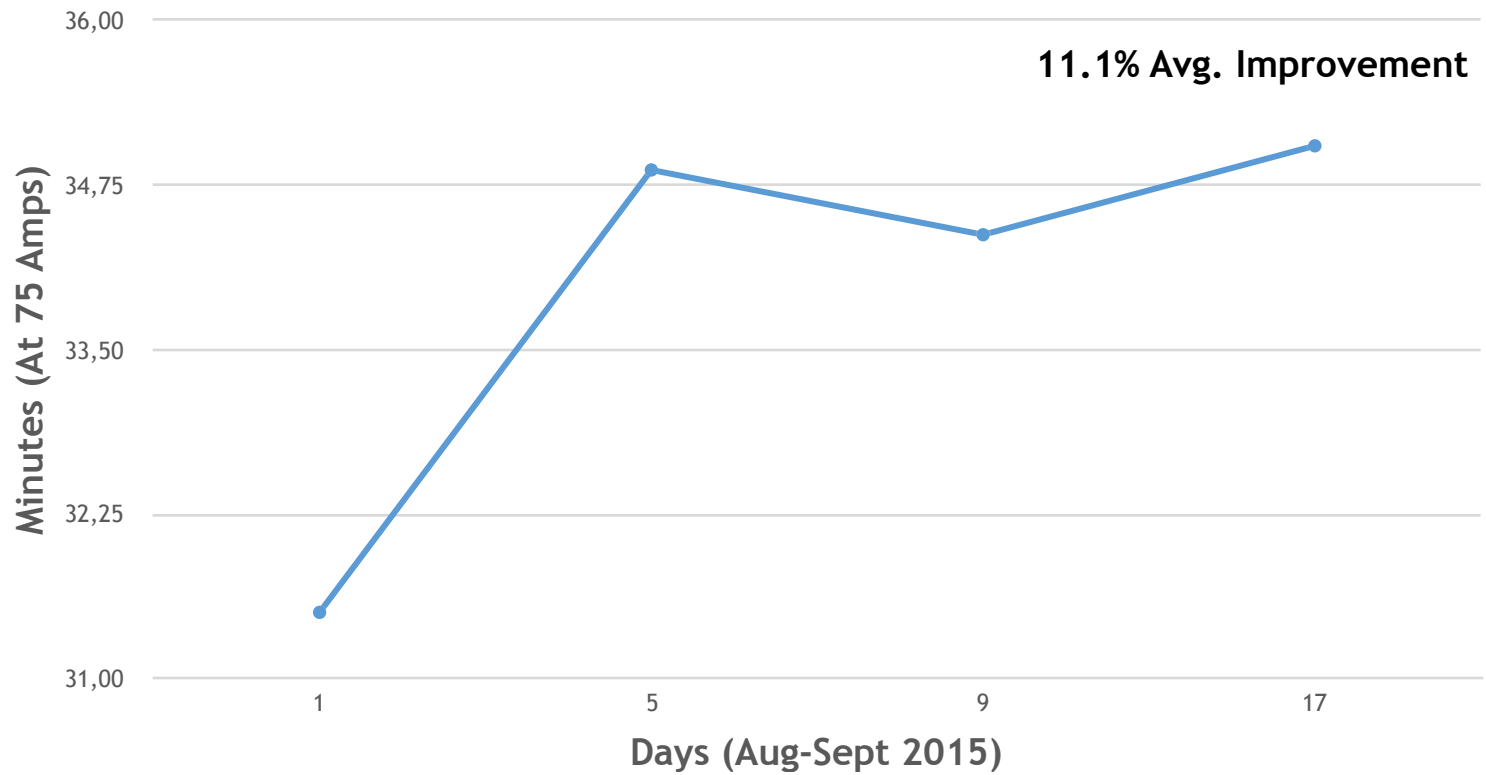

# Manufactured in USA

---

- TT Electronics, Perry Ohio
  - Printed Circuit Board Manufacturing
  - [www.ttelectronics-ims.com](http://www.ttelectronics-ims.com)
  
- Meritec, Painesville Ohio
  - Over-mold encapsulation
  - [www.meritec.com](http://www.meritec.com)



# Next Steps

---

- Invite for Quality Review of Canadus and Manufacturers
- Aftermarket?
  - Warranty claims on batteries?
  - Dealer maintenance programs?
- OEM Consideration Requirements?





# Battery Reconditioner Extends Battery Life

---



New Battery Plate



Sulfated Battery Plate



Battery Plate Partially  
Desulfated by  
Reconditioner



Battery Plate Desulfated by  
Reconditioner

